



**C. Emery Nelson, Inc.**

INDUSTRIAL AND POWER PLANT EQUIPMENT

7631 Commerce Street, Hamel, MN 55340  
Ph: 763/ 420-3844 Fax: 763/420-2542

# PARTS LIST OPERATING AND SERVICE MANUAL



## 4800 SERIES BLOWERS

**Model**  
GKG\_\_C\_

**SB-7-623**  
**Version 03**  
**February, 2006**

**MAINTAIN BLOWER RELIABILITY AND PERFORMANCE  
WITH GENUINE GARDNER DENVER  
PARTS AND SUPPORT SERVICES**

Factory genuine parts, manufactured to design tolerances, are developed for optimum dependability --- specifically for your blower. Design and material innovations are born from years of experience with hundreds of different blower applications. When you specify factory genuine parts you are assured of receiving parts that incorporate the most current design advancements . . . manufactured in our state-of-the-art blower factory under exacting quality standards.

Your **AUTHORIZED DISTRIBUTOR** offers all the backup you require. A worldwide network of authorized distributors provides the finest product support in the blower industry.

Your **AUTHORIZED DISTRIBUTOR** can support your

blower investment with these services:

1. Trained parts technical representatives to assist you in selecting the correct replacement parts.
2. Complete inventory of new machines and new, genuine factory parts.
3. A full line of factory tested AEON™ PD blower lubricants specifically formulated for optimum performance in all blowers.
4. Authorized Distributor service technicians are factory-trained and skilled in blower maintenance and repair. They are ready to respond and assist you by providing fast, expert maintenance and repair services.

**INSTRUCTIONS FOR DETERMINING BLOWER CONFIGURATION**

1. Face the blower drive shaft.
2. In a **VERTICAL** configuration, air flow is horizontal.
3. In a **HORIZONTAL** configuration, air flow is vertical.
4. In a vertical configuration, a **BOTTOM HAND** exists when the drive shaft is below the horizontal center line of the blower. A **TOP HAND** exists when the drive shaft is above the horizontal center line of the blower.
5. In a horizontal configuration, a **RIGHT HAND** exists when the drive shaft is to the right of the vertical center line of the blower. A **LEFT HAND** exists when the drive shaft is to the left of the vertical center line of the blower.

**INSTRUCTIONS FOR ORDERING REPAIR PARTS**

For pricing and ordering information, contact your nearest **AUTHORIZED FACTORY DISTRIBUTOR**.

When ordering parts, specify Blower **MODEL** and **SERIAL NUMBER** (see nameplate on unit).

Rely upon the knowledge and experience of your **AUTHORIZED DISTRIBUTOR** and let them assist you in making the proper parts selection for your blower.

**For the location of your local authorized Gardner Denver blower distributor refer to the yellow pages of your phone directory, check the Web site at [www.gardnerdenver.com](http://www.gardnerdenver.com) or contact:**



## FOREWORD

Sutorbilt® blowers are the result of advanced engineering and skilled manufacturing. To be assured of receiving maximum service from this machine the owner must exercise care in its operation and maintenance. This book is written to give the operator and maintenance department essential information for day-to-day operation, maintenance and adjustment. Careful adherence to these instructions will result in economical operation and minimum downtime.

### **DANGER**

**Danger is used to indicate the presence of a hazard which will cause severe personal injury, death, or substantial property damage if the warning is ignored.**

### **WARNING**

**Warning is used to indicate the presence of a hazard which can cause severe personal injury, death, or substantial property damage if the warning is ignored.**

### **CAUTION**

**Caution is used to indicate the presence of a hazard which will or can cause minor personal injury or property damage if the warning is ignored.**

### **NOTICE**

**Notice is used to notify people of installation, operation or maintenance information which is important but not hazard-related.**

## SAFETY PRECAUTIONS

Safety is everybody's business and is based on your use of good common sense. All situations or circumstances cannot always be predicted and covered by established rules. Therefore, use your past experience, watch out for safety hazards and be cautious. Some general safety precautions are given below:

### **DANGER**

Failure to observe these notices could result in injury to or death of personnel.

- **Keep fingers and clothing away** from blower inlet and discharge ports, revolving belts, sheaves, drive coupling, etc.
- **Do not use the air discharge** from this unit for breathing - not suitable for human consumption.
- **Do not loosen or remove** the oil filler plug, drain plugs, covers, or break any connections, etc., in the blower air or oil system until the unit is shut down and the air pressure has been relieved.
- **Electrical shock** can and may be fatal.
- **Blower unit must be grounded** in accordance with the National Electrical Code. A ground jumper equal to the size of the equipment ground conductor must be used to connect the blower motor base to the unit base.
- **Open main disconnect switch**, tag and lockout before working on the control.
- **Disconnect the blower** unit from its power source, tag and lockout before working on the unit - the machine may be automatically controlled and may start at any time.

### **WARNING**

Failure to observe these notices could result in damage to equipment.

- **Stop the unit** if any repairs or adjustments on or around the blower are required.
- **Disconnect the blower** unit from its power source, tag and lockout before working on the unit - the machine may be automatically controlled and may start at any time.
- **Do not exceed** the rated maximum speed shown on the nameplate.
- **Do not operate unit** if safety devices are not operating properly. Check periodically. Never bypass safety devices.

## TABLE OF CONTENTS

### Page

Maintain Blower Reliability and Performance with Genuine Gardner Denver Parts and Support Services . . . . .	i
Instructions for Ordering Repair Parts . . . . .	i
Instructions for Determining Blower Configuration . . . . .	i
Foreword . . . . .	ii
Safety Precautions . . . . .	iii
Index . . . . .	v
List of Illustrations . . . . .	v
Sutorbilt 7" - 4800 Blower Matrix/Menu . . . . .	vi
Introduction, Your Key To Trouble Free Service . . . . .	1
Section 1, General Information . . . . .	2
Section 2, Installation . . . . .	5
Section 3, Lubrication . . . . .	10
Section 4, Operation . . . . .	12
Section 5, Maintenance and Troubleshooting . . . . .	15
Section 6, Parts List and Exploded View . . . . .	16
Warranty . . . . .	Last Page

## INDEX

<p>Air Seal Vent Systems ..... 9</p> <p>Alignment, Belt Drive ..... 7</p> <p>Base and Foundation ..... 5</p> <p>Belt Drive Alignment ..... 7</p> <p>Checklist, Start-Up ..... 11</p> <p>Configuration, Changes ..... 4</p> <p>Configurations, Mounting ..... 5</p> <p>Drive Installation ..... 5</p> <p>Driver Location ..... 5</p> <p>Sutorbilt Technical Support ..... i</p> <p>Exploded Views ..... 16</p> <p>Filling Procedure ..... 8</p> <p>Foundation and Base ..... 5</p> <p>GENERAL INFORMATION, SECTION 1 ..... 2</p> <p>Inspection ..... 2</p> <p>Installation, Drive ..... 5</p> <p>INSTALLATION, SECTION 2 ..... 7</p> <p>Introduction ..... 2</p> <p>Key Points to Long Blower Life ..... 13</p> <p>Limitations, Operation ..... 10</p> <p>Location ..... 5</p> <p>Location, Driver ..... 5</p> <p>Long Blower Life, Key Points ..... 13</p> <p>Lubricant, Recommended ..... 8</p> <p>LUBRICATION, SECTION 3 ..... 8</p> <p>Lubrication</p> <p style="padding-left: 20px;">Filling Procedure ..... 8</p> <p style="padding-left: 20px;">Recommended Lubricant ..... 8</p>	<p>Lubrication Service</p> <p style="padding-left: 20px;">Air Seal Vent Systems ..... 9</p> <p style="padding-left: 20px;">Oil Sump Breathing System ..... 9</p> <p>MAINTENANCE AND TROUBLESHOOTING, SECTION 5 ..... 13</p> <p>Matrix/Menu ..... vi</p> <p>Mounting Configurations ..... 5</p> <p>Oil Sump Breathing Systems ..... 9</p> <p>OPERATION, SECTION 4 ..... 10</p> <p>Overhung Load Calculations and Limitations ..... 5</p> <p>PARTS LIST AND EXPLODED VIEW, SECTION 6 ..... 16</p> <p>Parts Ordering Instructions ..... 15</p> <p>Piping ..... 7</p> <p>Precautions, Safety ..... iii, 12</p> <p>Protective Material, Removal ..... 2</p> <p>Recommended Lubricant ..... 8</p> <p>Removing Protective Material ..... 2</p> <p>Repair Parts, Ordering Instructions ..... i, 15</p> <p>Safety Precautions ..... iii, 12</p> <p>Service, Lubrication ..... 9</p> <p>Start-Up Checklist, Blower ..... 11</p> <p>Storage ..... 2</p> <p>Troubleshooting ..... 13</p> <p>WARRANTY ..... Last Page</p> <p>YOUR KEY TO TROUBLE FREE SERVICE, INTRODUCTION ..... 1</p>
-----------------------------------------------------------------------------------------------------------------------------------------------------------------------------------------------------------------------------------------------------------------------------------------------------------------------------------------------------------------------------------------------------------------------------------------------------------------------------------------------------------------------------------------------------------------------------------------------------------------------------------------------------------------------------------------------------------------------------------------------------------------------------------------------------------------------------------------------------------------------------------------------------------------------------------------------------------------------------------------------------------------------------------------------------------------------------------------	----------------------------------------------------------------------------------------------------------------------------------------------------------------------------------------------------------------------------------------------------------------------------------------------------------------------------------------------------------------------------------------------------------------------------------------------------------------------------------------------------------------------------------------------------------------------------------------------------------------------------------------------------------------------------------------------------------------------------------------------------------------------------------------------------------------------------------------------------------------------------------------------------------------------------------------------------------------------------------------------------------------------------------------------------------------------------------------

## LIST OF ILLUSTRATIONS

1-1	OUTLINE DRAWING ..... 3	3
1-2	BLOWER OUTLINE DIMENSION CHART ..... 3	3
1-3	BLOWER CONFIGURATION CHANGES ..... 4	4
2-1	MAXIMUM ALLOWABLE MOMENT AND DRIVE SHAFT ILLUSTRATION ..... 6	6
2-2	ARC OF CONTACT FACTORS ..... 6	6
2-3	CALCULATION OF BELT PULL ..... 6	6
2-4	CALCULATION OF SHAFT MOMENT ..... 6	6
3-1	RECOMMENDED LUBRICANT ..... 8	8
3-2	APPROXIMATE OIL CAPACITIES ..... 8	8
3-3	LUBRICATION RECOMMENDATION ..... 9	9
4-1	MAXIMUM OPERATING LIMITATIONS ..... 10	10
	7" - 4800 SUTORBILT BLOWER EXPLODED VIEW ..... 16	16

**SUTORBILT BLOWERS SERIES 4800  
MATRIX/MENU**

NOTICE TO CUSTOMER - To find the construction options for your blower unit, FILL IN THE BALANCE OF LETTERS OR NUMBERS FROM YOUR UNIT NAMEPLATE

	G	K	G		C	A					
COLUMN NUMBER:	1	2	3	4	5	6	7	8	9	10	11

FOLLOW THE LINE DOWN AND OVER FROM EACH SPACE THUS FILLED IN TO FIND THE APPROPRIATE CONSTRUCTION OPTION WITH WHICH YOUR MACHINE IS EQUIPPED.

COLUMN 1 - BASIC DESIGNATOR \_\_\_\_\_

COLUMN 2 - PRODUCT FAMILY \_\_\_\_\_  
K. Industrial Blower

COLUMN 3 - GEAR DIAMETER \_\_\_\_\_  
G. 7"

COLUMN 4 - CASE LENGTH \_\_\_\_\_  
A. 23"  
B. 28"

COLUMN 5 - CONFIGURATION \_\_\_\_\_  
A. Vertical-Top Hand-Central Timed  
B. Vertical-Bottom Hand-Central Timed  
C. Horizontal-Left Hand-Central Timed  
D. Horizontal-Right Hand-Central Timed

COLUMN 6 - DESIGN VERSION \_\_\_\_\_

COLUMN 7 - ADDITIONAL DESCRIPTION \_\_\_\_\_  
A. Standard, No Modification

COLUMNS 8 THRU 11 - MODIFICATION NUMBER \* \_\_\_\_\_  
\* Not Included In This Publication, Consult Factory

## **INTRODUCTION**

### **YOUR KEY TO TROUBLE FREE SERVICE**

---

Thank you for investing in Sutorbilt quality. The Sutorbilt reputation for rugged dependability has been earned by over 70 years of service in demanding, industrial operations where downtime cannot be tolerated and efficient blower performance is expected.

Your Sutorbilt blower is a precision engineered blower that has been carefully manufactured and thoroughly tested at the state-of-the-art Gardner Denver Blower Factory in Sedalia, Missouri.

As with other precision machinery, there are several relatively simple installation, operation

and maintenance procedures that you must observe to assure optimum blower performance. There is no guesswork in the manufacture of your highly advanced Sutorbilt blower and there must be none in preparing the blower to get the job done in the field.

The purpose of this manual is to help you properly install, operate and maintain your blower. It is essential that you review all sections of this manual in preparation for installing your blower. Follow the instructions carefully and you will be rewarded with trouble free Sutorbilt service -- year in and year out.



# SECTION 1

## GENERAL INFORMATION

---

### INSPECTION

Before uncrating, check the packing slip carefully to be sure all the parts have been received. All accessories are listed as separate items on the packing slip and small important accessories such as relief valves can be overlooked or lost. After every item on the packing slip has been checked off, uncrate carefully. Register a claim with the carrier for lost or damaged equipment.

The inlet and discharge openings are fitted with protective covers to prevent dirt and moisture from entering the blower during shipping and installation.

### NOTICE

**Do not remove and dispose of the covers until final checking and installation.**

Covers are lined with a "Corrosion Inhibitor" which will inhibit rust for a period of six months. Retain covers for use in reshipment or relocation of the unit.

Temporarily remove the protective covers and inspect interior of air chamber for foreign material or heavy rusting. Turn driveshaft to assure that lobes rotate smoothly without binding. New blowers may be difficult to turn by hand due to friction of the air seals. Once in motion however, there should be no indication of interference between the rotors and the housing or endplates. Report any suspected mechanical problems immediately to your authorized Sutorbilt distributor.

### REMOVING PROTECTIVE MATERIALS AT START-UP

Blower inlet and discharge are temporarily capped to keep out dirt and other contaminants during shipment. These covers must be removed before start-up.

### WARNING

**Failure to remove covers from blower inlet and discharge prior to start-up will cause machine damage.**

### STORAGE

Your blower was packaged at the factory with adequate protection to permit normal storage for up to six (6) months. Under the best of storage conditions there is still a potential for damage to occur. Extended storage preparation is available from the factory, prior to shipment, at a small additional charge. If the unit is to be stored under adverse conditions or for extended periods of time, additional measures should be taken to prevent unwarrantable damage.

1. Store the blower in a clean, dry area.
2. Make certain inlet and discharge air ports are tightly covered to prevent foreign material from entering the air chamber.
3. All exposed, non-painted surfaces should be protected against rust and corrosion.
4. Make sure all vent breathers are in place.
5. Provide adequate protection to avoid accidental mechanical damage.
6. In high humidity or corrosive environments, additional measures may be required to prevent rusting of the internal surfaces. Mist spraying the impellers and air chamber with a rust preventative will protect these surfaces from rusting. To prevent rusting of gears and bearings, fill the oil reservoirs completely with normal operating oil.

### CAUTION

**Before running the blower, drain the oil and replace to the proper operating level with clean, fresh lubricant.**

### WARNING

**Rotating components will cause severe injury in case of personal contact. Keep hands away from blower inlet and discharge ports.**

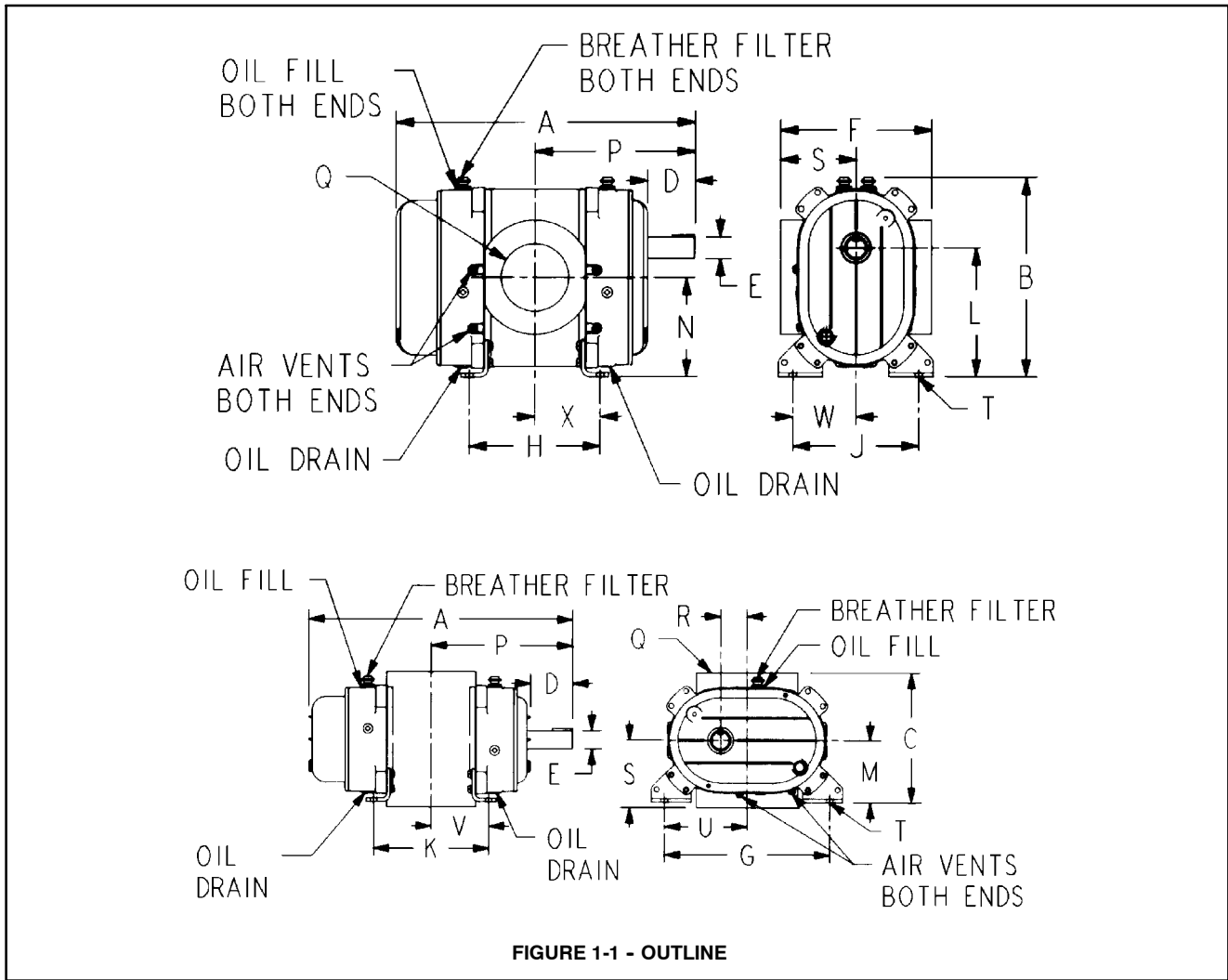
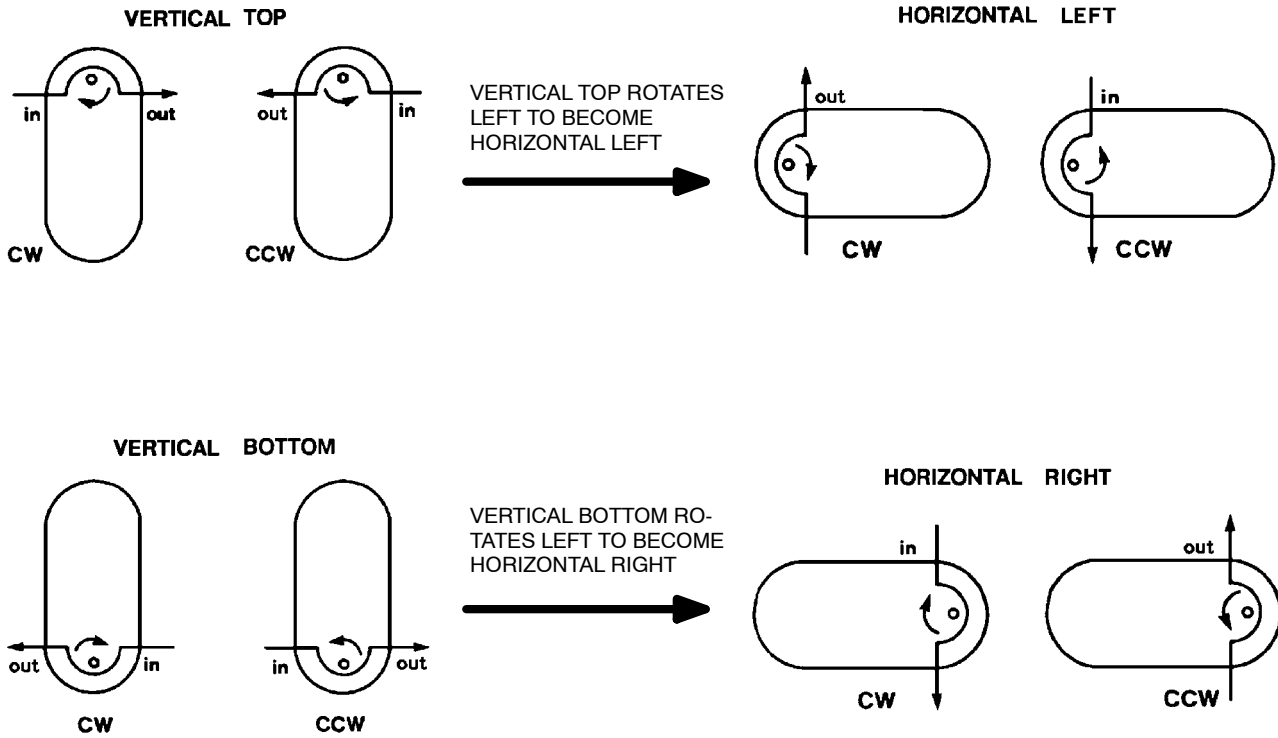

FIGURE 1-1 - OUTLINE

723			
A.	46.44	M.	8.25
B.	23.62	N.	11.75
C.	17.25	P.	24.47
D.	5.62	Q.	12" FLG
E. DIA	2.500	R.	3.50
F.	18.00	S.	9.00
G.	22.00	T.	.88
H.	26.50	U.	11.00
J.	15.00	V.	13.25
K.	26.50	W.	7.50
L.	15.25	X.	15.75
APPROXIMATE WEIGHT 1160			

728			
A.	51.44	M.	8.25
B.	23.62	N.	11.75
C.	17.25	P.	26.97
D.	5.62	Q.	12" FLG
E. DIA	2.500	R.	3.50
F.	18.00	S.	9.00
G.	22.00	T.	.88
H.	31.50	U.	11.00
J.	15.00	V.	15.75
K.	31.50	W.	7.50
L.	15.25	X.	15.75
APPROXIMATE WEIGHT 1260			

FIGURE 1-2 - BLOWER OUTLINE DIMENSION CHART



**SHAFT ROTATION KEY:**      CW = CLOCKWISE  
                                          CCW = COUNTERCLOCKWISE

**NOTE:** When changing configurations be sure to relocate Oil Fill, Oil Drain and Breather Filters into their proper positions.

**FIGURE 1-3 - BLOWER CONFIGURATION CHANGES**

## SECTION 2 INSTALLATION

### LOCATION

Whenever possible, install the blower in a clean and dry place that is both well lighted and well ventilated. Provide plenty of room for easy inspection and maintenance.

### FOUNDATION AND BASE

For permanent installations we recommend concrete foundations be provided, and the equipment should be grouted to the concrete. It is necessary that a suitable base be used, such as steel combination base under the blower and motor, or a separate sole plate under each. Before grouting, equipment must be leveled, free of all strains, and anchored so no movement will occur during curing of grout. After grout has completely hardened, a recheck is necessary to compensate for shrinkage. If required, add shims under blower feet after final tightening of foundation anchor bolts to remove strain from the blower housing.

Where jack screws or wedges are used during grouting, they must be backed off or removed before final tightening of anchor bolts.

Where a concrete foundation is not feasible, care must be taken to insure that equipment is firmly anchored to adequate structural members. The blower must be installed on a flat, level surface and bolted down evenly to prevent warping or strain. Internal clearances are very critical and serious damage or failure can result from housing distortion.

### NOTICE

**If unit is not flat within .002 of an inch, it will be necessary to shim the blower feet at installation.**

### MOUNTING CONFIGURATIONS

All Sutorbilt blowers are center timed allowing rotation in either direction.

Sutorbilt blowers are shipped in the vertical configuration (horizontal airflow.) If a horizontal configuration is desired, the blower can be laid on its side after repositioning breathers, oil filler drain plugs and mounting feet as indicated in the installation drawing, FIGURE 1-1, page 3. **To assure proper lubrication, the blower must be laid over in the direction that places the oil**

**sight glass(es) below the horizontal centerline of the blower.** See FIGURE 1-3, page 4, for additional configuration information.

Blowers can be converted from vertical to horizontal configurations utilizing the same four (4) feet originally shipped with the blower.

The blower must be mounted level with the driveshaft in the horizontal position.

### DRIVE INSTALLATION

When selecting a V-belt drive, check to be sure the shaft overhung load limitation is not exceeded.

**Overhung Load Calculations and Limitations** – An excessive overhung condition exists when the belt pull on the blower shaft exceeds the maximum allowable moment listed in the chart in FIGURE 2-1. Excessive overhung load conditions must be avoided or bearing failure and shaft breakage will result.

### WARNING

**Exceeding overhung load limitation leads to unwarrantable premature bearing failure and shaft breakage.**

The location of the sheave on the blower shaft greatly affects the stress in the shaft. The optimum blower sheave positioning is as close as possible to the blower drive cover, not to exceed dimension "C" shown in FIGURE 2-1, page 6.

To calculate the shaft moment for a given V-belt drive arrangement, first calculate the belt pull using the formula in FIGURE 2-3. Insert the calculated belt pull into the formula in FIGURE 2-4 to arrive at the calculated shaft moment.

The calculated shaft moment must not exceed the maximum allowable moment listed in FIGURE 2-1, page 6. If the calculated shaft moment exceeds the maximum allowable moment:

- Increase Sheave Diameters to Reduce Belt Pull
- Use Jackshaft Drive
- Use Direct Coupled or Gearbox Drive

**Driver Location** – To properly balance the air load stress on the blower drive shaft, locate the driver on the inlet side for a vertical mounted blower and on the shaft side for a horizontal mounted blower.

Gear Diameter (Inches)	Dimensions (Inches)			Maximum Allowable Moment (LB-IN)
	A	B	C (Max)	
7	9.45	3.82	.63	14469

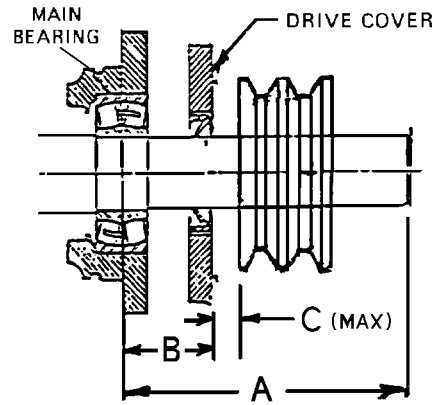

FIGURE 2-1 - MAXIMUM ALLOWABLE MOMENT AND DRIVE SHAFT ILLUSTRATION

Z	Ac	Z	Ac	Z	Ac	Z	Ac	Z	Ac	Z	Ac
0.000	1.000	0.250	0.966	0.500	0.926	0.750	0.879	1.000	0.823	1.250	0.751
0.025	0.997	0.275	0.962	0.525	0.922	0.775	0.874	1.025	0.816	1.275	0.742
0.050	0.994	0.300	0.958	0.550	0.917	0.800	0.869	1.050	0.810	1.300	0.734
0.075	0.990	0.325	0.954	0.575	0.913	0.825	0.864	1.075	0.803	1.325	0.725
0.100	0.987	0.350	0.951	0.600	0.908	0.850	0.858	1.100	0.796	1.350	0.716
0.125	0.983	0.375	0.947	0.625	0.904	0.875	0.852	1.125	0.789	1.375	0.706
0.150	0.980	0.400	0.943	0.650	0.899	0.900	0.847	1.150	0.782	1.400	0.697
0.175	0.977	0.425	0.939	0.675	0.894	0.925	0.841	1.175	0.774	1.425	0.687
0.200	0.973	0.450	0.935	0.700	0.889	0.950	0.835	1.200	0.767		
0.225	0.969	0.475	0.930	0.725	0.884	0.975	0.829	1.225	0.759		

FIGURE 2-2 - ARC OF CONTACT FACTORS

$$\text{Belt Pull} = \left[ \frac{2.5 - A_c}{A_c} \right] \left[ \frac{125954 \times \text{Hp} \times \text{S.F.}}{D \times \text{RPM}} \right]$$

- Key:
- A<sub>c</sub> = Arc of Contact Factor (Refer to Arc of Contact Factors Chart above)
  - H<sub>p</sub> = Blower Horsepower for Operating Conditions
  - S.F. = Actual Drive Service Factor
  - D = Blower Sheave Pitch Diameter in Inches
  - RPM = Blower Sheave Speed
  - Z =  $\frac{\text{Large Sheave Pitch Diameter (in)} - \text{Small Sheave Pitch Diameter (in)}}{\text{Sheave Center Distance (in)}}$

FIGURE 2-3 - CALCULATION OF BELT PULL

$$\text{Shaft Moment (LB-IN)} = \text{Belt Pull} \times \left[ B + C + \left( \frac{\text{Sheave Width}}{2} \right) \right]$$

FIGURE 2-4 - CALCULATION OF SHAFT MOMENT

**Belt Drive Alignment** - Belt drives must be carefully aligned, with the motor and blower sheaves parallel to each other and in the same plane. Belt tension should be carefully adjusted according to the belt manufacturer's recommendations using a Tension Tester.

On direct drive blowers, align the couplings so that the offset and angular misalignment does not exceed .003" total indicator reading (TIR). Lubricate coupling according to manufacturer's specification. With factory installed drives, proper alignment has been established before shipment. During shipping, handling and installation, it is likely that the alignment has been disturbed and final adjustment must be made before start-up.

### **PIPING**

The 7"-4800 Series blowers have flat face inlet and discharge flanges with ANSI 125 lb. bolt patterns.

When installing the blower, avoid subjecting the inlet and discharge connections to strains caused by

misalignment of the connecting pipes. Never allow the blower to carry the weight of the pipe.

Piping strain and misalignment stress will distort the blower during operation, resulting in loss of critical internal clearances. Loss of internal clearances will result in serious machine damage and premature, **unwarrantable** blower failure.

Whenever possible, install a spool or sleeve-type expansion joint between the blower and the piping. Where a flexible connection is not possible, the weight of the rigid connection and piping must be separately supported, and thermal pipe growth must be accommodated.



### **WARNING**

**Thoroughly clean all system piping internally before connecting to blower.**

## SECTION 3 LUBRICATION

Every blower is lubricated and thoroughly tested at the factory, after which the oil is drained for shipping.

 <b>WARNING</b>
<b>Sutorbilt blowers are shipped dry from the factory. Do not attempt to operate the blower before following proper lubrication instructions. Permanent damage to the gears, bearings and seals will occur.</b>

All blowers are splash oil lubricated at both the gear and drive ends. Oil is distributed around the gear housing and drive end chamber by the gears and specially designed oil flingers.

### FILLING PROCEDURE

7"-4800 series models have separate oil sumps. Oil must be added to each end of the blower through the oil breather ports (see FIGURE 1-1, page 3.)

 <b>WARNING</b>
<b>Failure to add oil to each end of the blower will result in damage to the blower.</b>

Add oil until the oil levels stabilize at the center of the sight glass(es).

Oil level at the sight glass must be established when the blower is not operating. When the blower is running, depending upon the blower rotation, the oil level will show above or below the centerline of the sight glass.

Do not overfill as this will cause excessive oil temperature and decreased lubricant life.

 <b>WARNING</b>
<b>Do not overfill as this will tend to cause excessive heating of the gears and may damage the unit.</b>

### RECOMMENDED LUBRICANT

Blower Discharge Temperature		Factory Tested Recommended and Approved Lubricant
° F	° C	
32°	0°	<b>AEON PD</b> Synthetic Blower Lubricant One Superior Lubricant For All Operating Temperatures
100°	38°	
275°	135°	
350°	177°	

FIGURE 3-1 - RECOMMENDED LUBRICANT

AEON PD is formulated especially for positive displacement blower service to provide maximum blower protection at any operating temperature. One filling of AEON PD will last a minimum of 4 times longer than a premium mineral oil, depending on actual operating conditions.

AEON PD 1 Quart Bottle, Part Number 28G23

AEON PD 12 Quart Case, Part Number 28G24

AEON PD 5 Gallon Pail, Part Number 28G25

AEON PD 55 Gallon Drum, Part Number 28G28

Oil Fill Ports	Vertical Mounting	Horizontal Mounting
One Port Shaft End	52 oz.	91 oz.
One Port Gear End	66 oz.	125 oz.

FIGURE 3-2 - APPROXIMATE OIL CAPACITIES

If not using AEON PD synthetic blower lubricant, use an oil with rust and oxidation inhibitors, anti-foam additives and the viscosities listed in FIGURE 3-3, page 9.

## LUBRICATION SERVICE

Add fresh oil as required to maintain proper level. If premium grade mineral oil is used, the oil should be drained, the gearbox flushed and the oil replaced every 500 hours of operation or more frequently if inspection indicates oil breakdown. With AEON PD synthetic blower lubricant, perform the above oil change maintenance after 2000 hours of operation. For the location of the oil drain plug see FIGURE 1-1, page 3.

### Air Seal Vent Systems

All blowers are designed with a vent opening between the air chamber seal and the oil sump seal that vents to atmosphere any air which escapes from the air chamber. The vent prevents pressurization of the oil sump and must be left open to atmosphere. The vent holes are tapped 3/8" NPT to permit installation of a venting line. Do not plug these vent holes (see FIGURE 1-1, page 3).

## WARNING

**Do not plug vent holes or oil sumps may pressurize causing loss of oil, excessive heat and serious damage to the machine.**

### Oil Sump Breathing System

All blowers are designed to permit their oil systems to breathe freely to prevent pressurization of the oil sumps. Breather filters are required to keep contaminants from entering the oil sumps (see FIGURE 1-1, page 3).

Breather filters are easily cleaned by washing in commercial solvent and drying with compressed air. Clean at every oil change to assure proper venting.

Blower Discharge Temperature	Oil Grade U.S.A.	Oil Viscosity Centistokes @ 40° C
32° to 100° F (0° to 38° C)	SAE 20	100
100° to 275° F (38° F to 135° F)	SAE 40	200
275° F to 300° F (135° to 149° C)	SAE 50	250
Over 300° F (149° C)	Consult Customer Service	

FIGURE 3-3 - LUBRICATION RECOMMENDATION



## SECTION 4 OPERATION

Future operating problems can be avoided if proper precautions are observed when the equipment is first put into service.

Before starting under power, the blower should be turned over by hand to make certain there is no binding, or internal contact.

### LIMITATIONS

Each size blower has limits on pressure differential, running speed, and discharge temperature which must not be exceeded. These limits are shown in FIGURE 4-1.

### WARNING

**Operating beyond the specified operating limitations will result in damage to the unit.**

To accurately determine actual blower operating conditions, it is important that all pressure and temper-

ature recordings are made directly at the ports of the blower where these conditions are at their maximum.

Relief valves **MUST** be used to protect the blower against excessive pressure or vacuum conditions. These valves should be tested at initial startup to be sure they are adjusted to relieve at 2 psi above the maximum allowable pressure and at 2" HG below the allowable vacuum for the blower. Periodic testing of relief valves is suggested to assure that they are functioning.

### NOTICE

**Relief valves should be placed as close as possible to the blower inlet or discharge.**

Check valves must be installed on the discharge side of the blower on a pressure system and on the inlet side of the blower on a vacuum system to eliminate product ingestion resulting from auto-rotation and blow back during equipment shutdown.

MAXIMUM OPERATING LIMITATIONS				
SIZE	RPM	DIFFERENTIAL PRESSURE PSI	DRY* VACUUM IN HG	DISCHARGE TEMPERATURE °F
723	2600	12	16	325
728	2600	10	16	325
<b>DO NOT EXCEED THESE LIMITS</b>				
* Increased vacuum levels attainable with water injection. Contact your Sutorbilt Distributor.				
NOTICE				
<b>Blower speed, line losses, elevation, and increased inlet temperatures will affect the maximum operating limitations.</b>				

FIGURE 4-1 - MAXIMUM OPERATING LIMITATIONS

## BLOWER STARTUP CHECKLIST

This startup procedure should be followed during the initial installation and after any shutdown periods or after the blower has been worked on or moved to a new location. It is suggested that the steps be followed in sequence and checked off ( ✓ ) in the boxes provided.

1. Check to make certain that the blower has been properly lubricated with AEON PD Synthetic Blower Lubricant. Proper oil level cannot be overemphasized. Too little oil will ruin bearings and gears. Too much oil will overheat the lubricant and lead to serious blower damage.
2. Check to make sure all oil sump breather filters are installed in their proper location. Oil leakage will occur if they are improperly located.
3. Check the unit and all piping for foreign material and clean if required.
4. Check the inlet or inline filter to make sure it is not plugged causing dangerous inlet restriction.
5. Check the preload of the feet and the alignment of the drive. Feet that are bolted down in a bind can cause case distortion and internal rubbing. A misaligned V-belt drive will reduce belt life. Misaligned couplings place heavy loads on bearings which leads to premature failure.
6. If blower is V-belt driven, check the belt tension. Over-tensioned belts create heavy bearing loads which leads to premature bearing failure.
7. If blower is V-belt driven, check for excessive overhung load condition. Loads in excess of maximum allowable overhung load limitations will lead to premature bearing failure and shaft breakage.
8. Be sure adequate drive guards are in place to protect the operator from **SEVERE PERSONAL INJURY** from incidental contact.
9. Turn the unit over by hand to be sure there is no binding or rotor contact. Special wear-in seals are utilized in Sutorbilt blowers. When units are new, some resistance to turning the driveshaft by hand will be encountered. After several hours of running, this seal pressure will relieve itself and the blower will be somewhat easier to turn.
10. Jog the blower with the motor to check for proper rotation and airflow direction. Listen for unusual noises coming from the blower or motor and make sure the blower coasts smoothly to a stop.
11. Start the unit and operate 15 minutes with no load. Check for hot spots on housing or end plates, noise and other indications of interference. Allow the blower to cool to room temperature and re-check oil level. Add oil if necessary. **DO NOT OVERFILL.**
12. Check to be certain that actual blower speed is within allowable limits.
13. Apply load and observe the operation for the first hour, checking pressure and air discharge temperature:
  - (a) Do not operate blower over manufacturer's specified pressure or vacuum rating.
  - (b) Discharge air temperature should not exceed the maximum allowable temperature.
14. Check and retension belts after the first few hours of operation to minimize slippage and belt wear. **DO NOT OVERTIGHTEN.**
15. If mechanical problems are encountered during installation or start-up, notify your nearest Sutorbilt Distributor. Never continue to operate your blower if you detect a malfunction, as serious damage can occur. **Do not attempt any internal investigation without factory authorization since this will void the warranty.**

## **SAFETY PRECAUTIONS**

### **Prevent bodily injury and equipment damage:**

1. Do not operate blower with an open inlet or discharge port.
2. Do not exceed specified vacuum or pressure limitations.
3. Do not operate the blower above or below recommended speed range.
4. Blower is not to be used where non-sparking equipment is specified. Contact your Sutorbilt Distributor for non-sparking requirements.
5. Do not operate without the belt guard or coupling shield properly installed.
6. Do not exceed the manufacturer's specified rim speed limit for sheaves or couplings.
7. The blower and blower discharge piping may be extremely hot and can cause skin burns on contact.
8. Do not exceed the manufacturer's certification levels for vacuum or pressure vessels.

## SECTION 5 MAINTENANCE AND TROUBLESHOOTING

Your Sutorbilt blower has been designed, manufactured and tested to precise specifications. Every blower is backed by over 70 years of proven performance in the most demanding applications that modern industry can produce. Sutorbilt blowers have been designed specifically for long, trouble-free service. Minimal maintenance is required to keep your blower in top operating condition. Your attention to the following key points will insure years of dependable blower performance.

### Key Points for Long Blower Life

1. Use AEON PD Synthetic Blower Lubricant to assure maximum blower protection.
2. The oil level must be checked periodically.
3. Drain and refill the blower with fresh AEON PD every 2000 hours of operation, 500 hours if using mineral based lubricant.
4. Clean the breather filters at every oil change or more often if dust conditions are severe.
5. Service the intake and in-line filters regularly to make sure that air flow restriction does not occur and that foreign material does not enter the blower.
6. If the blower is taken out of service for any reason, be sure to protect all interior surfaces from rusting.

### TROUBLE SHOOTING

No matter how well the equipment is designed and manufactured, there may be times when servicing will be required due to normal wear, the need for adjustment, or various external causes. Whenever

equipment needs attention, the operator or repairman should be able to locate the cause and correct the trouble quickly by following the Troubleshooting charge given below:

PROBLEM	POSSIBLE CAUSES	SOLUTION
Knocking and excessive mechanical noise.	1. Unit out of time.	1. Retime rotors. (See Page 15.)
	2. Distortion due to improper mounting or pipe strains.	2. Check mounting alignment and relieve pipe strains.
	3. Excessive pressure differential.	3. Reduce to manufacturer's recommended pressure or vacuum. Examine relief valve, re-set if necessary.
	4. Worn gears.	4. Replace timing gears. (See Page 15.)
	5. Worn bearings.	5. Replace bearings. (See Page 15.)
Excessive blower temperature.	1. Too much oil in gear case.	1. Reduce oil level.
	2. Too low operating speed.	2. Increase blower speed. Check sheave set.
	3. Clogged filter or muffler.	3. Remove cause of obstruction.
	4. Excessive pressure differential.	4. Reduce pressure differential across the blower.
	5. Worn impeller clearances.	5. Replace rotors. (See Page 15.)
	6. Internal contact.	6. Correct clearances. (See Page 15.)
	7. Excessive inlet temperature.	7. Relocate intake to cooler area.

<b>PROBLEM</b>	<b>POSSIBLE CAUSES</b>	<b>SOLUTION</b>
Rotor contact with housing or endplate.	<ol style="list-style-type: none"> <li>1. Insufficient assembled clearances.</li> <li>2. Case or frame distortion.</li> <li>3. Excessive operating pressure.</li> <li>4. Excessive operating temperature.</li> <li>5. Material ingestion through the blower.</li> </ol>	<ol style="list-style-type: none"> <li>1. Return for Warranty. (See Page 15.)</li> <li>2. Remove all mounting and pipe strains.</li> <li>3. Remove cause.</li> <li>4. Remove cause.</li> <li>5. Replace worn inlet and inline filters. Install check valve between blower and first material load point to eliminate blow-back when blower is stopped.</li> </ol>
Lack of CFM delivery.	<ol style="list-style-type: none"> <li>1. Slipping belts.</li> <li>2. Worn clearances.</li> <li>3. Blower RPM too slow.</li> </ol>	<ol style="list-style-type: none"> <li>1. Tighten belts.</li> <li>2. Replace rotors. (See Page 15.)</li> <li>3. Increase Blower speed. Check sheave set.</li> </ol>
Excessive bearing or gear wear.	<ol style="list-style-type: none"> <li>1. Improper lubrication.</li> <li>2. Oversized belt drive, over-tightened belts.</li> </ol>	<ol style="list-style-type: none"> <li>1. Correct lubrication level. Replace dirty oil.</li> <li>2. Re-tension belts to proper tightness. Check drive to eliminate possible overhung load condition.</li> </ol>
Loss of oil from seal vents.	<ol style="list-style-type: none"> <li>1. Worn oil seal.</li> <li>2. Damaged seal sleeve.</li> <li>3. Gear case or drive cover breathers plugged.</li> </ol>	<ol style="list-style-type: none"> <li>1. Replace oil seals. (See Page 15.)</li> <li>2. Replace sleeve. (See Page 15.)</li> <li>3. Clean breather filters.</li> </ol>
Loss of oil from breather filters.	<ol style="list-style-type: none"> <li>1. Endplate seal vents plugged.</li> <li>2. Worn oil seal.</li> </ol>	<ol style="list-style-type: none"> <li>1. Clean vents of obstruction. Do not plug seal vents.</li> <li>2. Replace seals. (See Page 15.)</li> </ol>
Loss of oil from driveshaft seal.	<ol style="list-style-type: none"> <li>1. Worn oil seal.</li> <li>2. Damaged seal sleeve.</li> </ol>	<ol style="list-style-type: none"> <li>1. Replace seals. (See Page 15.)</li> <li>2. Replace sleeve. (See Page 15.)</li> </ol>
Excessive vibration.	<ol style="list-style-type: none"> <li>1. Inadequate package design.</li> <li>2. Soft foot.</li> <li>3. Material build-up inside rotors.</li> <li>4. Bearing failure.</li> <li>5. Excessive gear wear.</li> <li>6. Bent shaft.</li> <li>7. Internal mechanical contact.</li> </ol>	<ol style="list-style-type: none"> <li>1. Reinstall base – fill with concrete.</li> <li>2. Shim to eliminate condition.</li> <li>3. Replace worn inlet and inline filters. Install check valve between blower and first material load point to eliminate blow-back when blower is stopped.</li> <li>4. Replace bearings.</li> <li>5. Replace gears.</li> <li>6. Replace rotor set.</li> <li>7. See “Rotor Contact” above.</li> </ol>

If you are unable to resolve the problem, contact your Sutorbilt Distributor for immediate assistance.

**Repair Parts**

If you elect to attempt a repair on your blower make certain you use genuine Sutorbilt original equipment parts to retain the performance and dependability of your blower.

Factory genuine parts, engineered to original tolerances, are designed for optimum dependability ...specifically for your blower. Design and material innovations are born from years of experience with hundreds of different blower applications. When you specify factory genuine parts you are assured of receiving parts that incorporate the most current design advancements . . . manufactured in our state-of-the-art blower factory under exacting quality standards.

Prepackaged overhaul kits are available for immediate shipment for all Sutorbilt blowers. Kits include all the

normal wearing parts needed to overhaul your blower: Oil seals, air seals, bearings, spacers, gaskets, and Belleville timing spring. Part numbers for overhaul kits are as follows:

7"-4800 Series Overhaul Kit Part Number

All Models ..... 200GGG6010

Refer to Section 6 for additional part numbers as required.

**Parts Ordering Instructions**

When ordering parts, indicate the model and serial number from the blower nameplate and identify the blower configuration by referring to FIGURE 1-3, page 4. For prompt, professional assistance in selecting the correct repair parts for your blower, contact your Distributor who maintains a large inventory of genuine parts.

# SECTION 6 PARTS LIST AND EXPLODED VIEWS

## 7" - 4800 SUTORBILT BLOWER

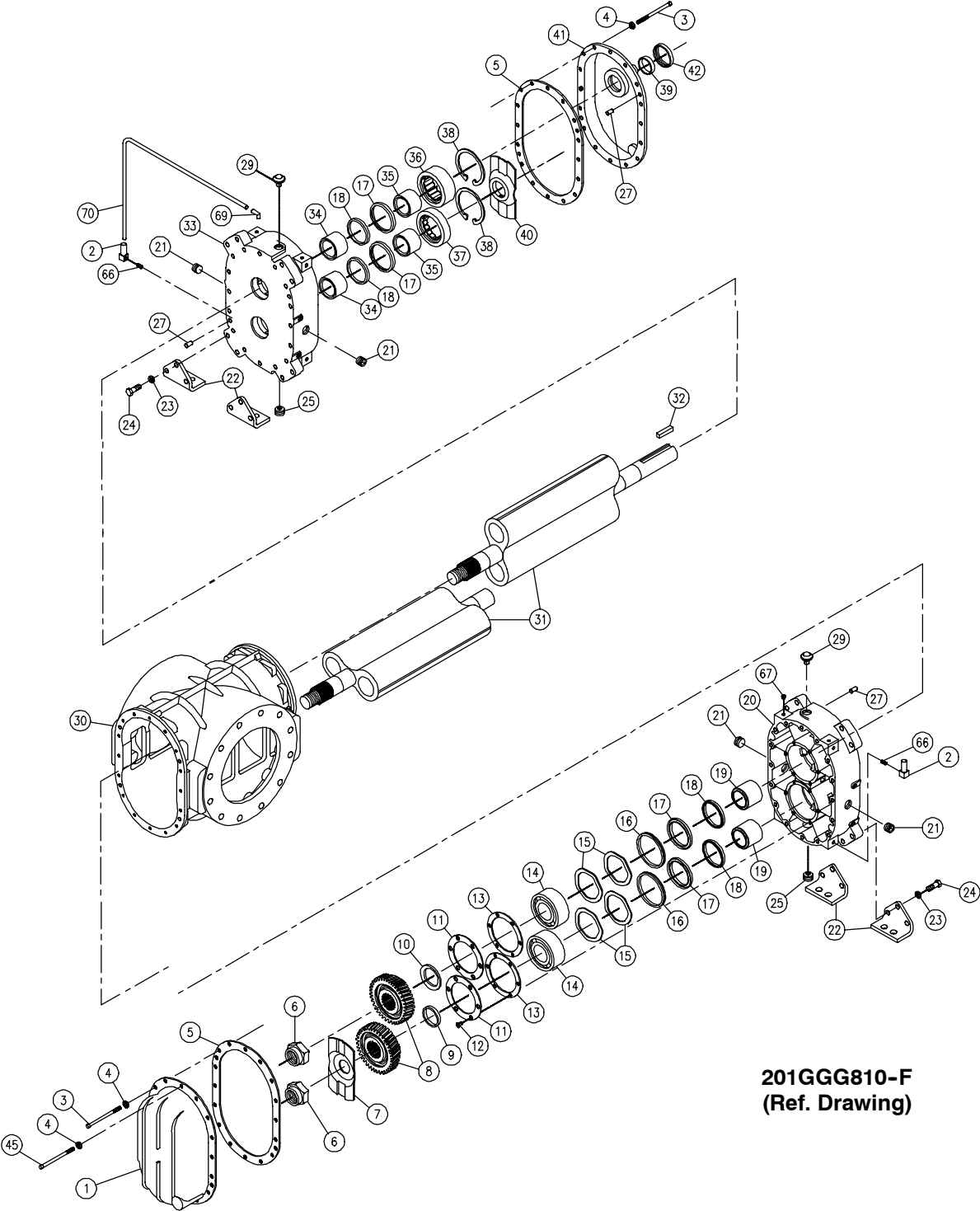

201GGG810-F  
(Ref. Drawing)

Order by Part Number and Description. Reference Numbers for your convenience only.

Parts List 7" - 4800 Sutorbilt

Ref. No	Name of Part	Qty.	Size 723 GKGA_C_	Size 728 GKGB_C_
1	COVER-GEAR .....	1	300GGG602	300GGG602
2	GLASS-SIGHT .....	2	40P55	40P55
3	SCREW-HEX HD CAP .....	32	655ED250	655ED250
4	WASHER-LOCK .....	32	95B3	95B3
* 5	GASKET .....	2	DF184031	DF184031
6	NUT-HEX LOCK .....	2	DF184086	DF184086
7	FLINGER .....	1	DF184024	DF184024
8	KIT-GEAR .....	1	200GGG6008	200GGG6008
9	SPACER .....	1	DF184028	DF184028
* 10	SPRING-BELLVILLE .....	1	DF184030	DF184030
11	RETAINER-BEARING .....	2	DF184019	DF184019
12	SCREW-HEX HD .....	12	75LM214	75LM214
* 13	SHIM SET .....	2	200GGG732	200GGG732
* 14	BEARING-BALL .....	2	12BA182	12BA182
15	WASHER-WAVY SPRING .....	4	8508481	8508481
16	SPACER-BEARING .....	2	DF185556	DF185556
* 17	SEAL-OIL .....	4	DF184084	DF184084
* 18	SEAL-LABYRINTH .....	4	DF184838	DF184838
20	ENDPLATE .....	1	301GGG006	301GGG006
21	PLUG-CSK HD .....	4	64B2	64B2
22	PLATE-MOUNTING .....	4	DF184949	DF184949
23	WASHER-LOCK .....	8	95B7	95B7
24	SCREW-HEX HD CAP .....	8	655EF080	655EF080
25	PLUG-MAGNETIC .....	2	64BJ3	64BJ3
27	PIN-DOWEL .....	6	62M82	62M82
29	BREATHER .....	2	5L223	5L223
30	CYLINDER .....	1	201GGG002	200GGG002
31	GROUP-ROTOR .....	1	210GGG4028	211GGG4028
32	KEY-SQUARE .....	1	2800T17	2800T17
33	ENDPLATE .....	1	300GGG006	300GGG006
* 36	BEARING-ROLLER .....	1	DF194014	DF194014
* 37	BEARING-ROLLER .....	1	DF194011	DF194011
38	RING-RETAINING .....	2	74D83	74D83
* 39	SLEEVE-WEAR .....	1	80L6	80L6
40	FLINGER ASM .....	1	DF189541	DF189541
** 41	COVER-DRIVE .....	1	300GGG477	300GGG477
* 42	SEAL-OIL .....	1	60DD709	60DD709
66	NIPPLE .....	2	63C4G	63C4G
69	ELBOW-TUBE - 90° .....	2	86E59	86E59
70	TUBE .....	2.0 FT.	85E4A	85E4A
* 70	KIT-OVERHAUL .....	0	200GGG6010	200GGG6010

\* Included in Overhaul Kit.

\*\* For Vertical Top and Horizontal Left hand shaft locations, for optional Vertical Bottom and Horizontal Right hand shaft locations use Part No. DF191446.



**GENERAL PROVISIONS AND LIMITATIONS**

Gardner Denver (the "Company") warrants to each original retail purchaser ("Purchaser") of its products from the Company or its authorized distributor that such products are, at the time of delivery to the Purchaser, made with good material and workmanship. No warranty is made with respect to:

1. Any product which has been repaired or altered in such a way, in the Company's judgment, as to affect the product adversely.
2. Any product which has, in the Company's judgment, been subject to negligence, accident, improper storage, or improper installation or application.
3. Any product which has not been operated or maintained in accordance with the recommendations of the Company.
4. Components or accessories manufactured, warranted and serviced by others.

Claims for items described in (4) above should be submitted directly to the manufacturer.

**WARRANTY PERIOD**

The Company's obligation under this warranty is limited to repairing or, at its option, replacing, during normal business hours at an authorized service facility of the Company, any part which in its judgment proved not to be as warranted within the applicable Warranty Period as follows.

**BARE BLOWERS**

Basic bare blowers, consisting of all parts within, are warranted for 12 months from date of initial use or 18 months from date of shipment to the first purchaser, whichever occurs first.

Any disassembly or partial disassembly of the blower, or failure to return the "unopened" blower per Company instructions, will be cause for denial of warranty.

**OTHER COMPONENTS**

All other components are warranted for 12 months from date of initial use or 18 months from date of shipment to first purchaser, whichever comes first.

The Company reserves the right to withdraw the Warranty where evidence indicates application outside the stated performance area, or where there is evidence of abuse

**LABOR TRANSPORTATION AND INSPECTION**

The Company will provide labor, by Company representative or authorized service personnel, for repair or re-

placement of any product or part thereof which in the Company's judgment is proved not to be as warranted. Labor shall be limited to the amount specified in the Company's labor rate schedule.

Labor costs in excess of the Company rate schedules caused by, but not limited to, location or inaccessibility of equipment, or labor provided by unauthorized service personnel is not provided by this warranty.

All costs of transportation of product, labor or parts claimed not to be as warranted and, of repaired or replacement parts to or from such service facilities shall be borne by the Purchaser. The Company may require the return of any part claimed not to be as warranted to one of its facilities as designated by the Company, transportation prepaid by Purchaser, to establish a claim under this warranty.

Replacement parts provided under the terms of the warranty are warranted for the remainder of the Warranty Period of the product upon which installed to the same extent as if such parts were original components.

**DISCLAIMER**

THE FOREGOING WARRANTY IS EXCLUSIVE AND IT IS EXPRESSLY AGREED THAT, EXCEPT AS TO TITLE, THE COMPANY MAKES NO OTHER WARRANTIES, EXPRESSED, IMPLIED OR STATUTORY, INCLUDING ANY IMPLIED WARRANTY OF MERCHANTABILITY.

THE REMEDY PROVIDED UNDER THIS WARRANTY SHALL BE THE SOLE, EXCLUSIVE AND ONLY REMEDY AVAILABLE TO THE PURCHASER AND IN NO CASE SHALL THE COMPANY BE SUBJECT TO ANY OTHER OBLIGATIONS OR LIABILITIES. UNDER NO CIRCUMSTANCES SHALL THE COMPANY BE LIABLE FOR ANY SPECIAL, INDIRECT, INCIDENTAL OR CONSEQUENTIAL DAMAGES, EXPENSES, LOSSES OR DELAYS HOWSOEVER CAUSED.

No statement, representation, agreement, or understanding, oral or written, made by any agent, distributor, representative, or employee of the Company which is not contained in this Warranty will be binding upon the Company unless made in writing and executed by an officer of the Company.

This warranty shall not be effective as to any claim which is not presented within 30 days after the date upon which the product is claimed not to have been as warranted. Any action for breach of this warranty must be commenced within one year after the date upon which the cause of action occurred.

Any adjustment made pursuant to this warranty shall not be construed as an admission by the Company that any product was not as warranted.

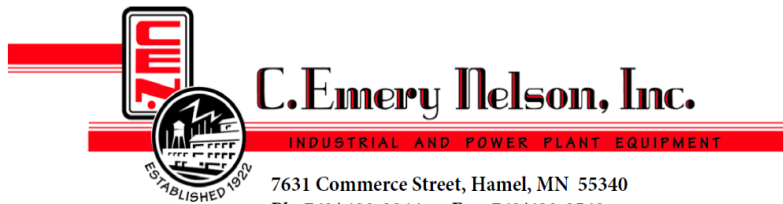

## C. Emery Nelson, Inc.

INDUSTRIAL AND POWER PLANT EQUIPMENT

7631 Commerce Street, Hamel, MN 55340  
Ph: 763/420-3844 Fax: 763/420-2542

For additional information, contact your local representative or

### Gardner Denver Compressor Division

1800 Gardner Expressway, Quincy, Illinois 62305

Phone (800) 682-9868 • Fax (217) 221-8780

E-mail: [pd.blowers@gardnerdenver.com](mailto:pd.blowers@gardnerdenver.com)

Visit our web site: [www.gardnerdenver.com](http://www.gardnerdenver.com)

Sales and Service in all major cities



# Gardner Denver

Specifications subject to change without notice  
© Copyright 2005 Gardner Denver, Inc. Litho in U.S.A.