



C. Emery Nelson, Inc.

INDUSTRIAL AND POWER PLANT EQUIPMENT

7631 Commerce Street, Hamel, MN 55340
Ph: 763/420-3844 Fax: 763/420-2542

Gardner Denver

POSITIVE DISPLACEMENT BLOWER PACKAGES

IQ Family



It's all about...

the Experience

A trusted & reliable brand, ensuring that you have the right blower package for the job

A REPUTATION EARNED BY A PROVEN HISTORY OF

Quality, Reliability & Performance

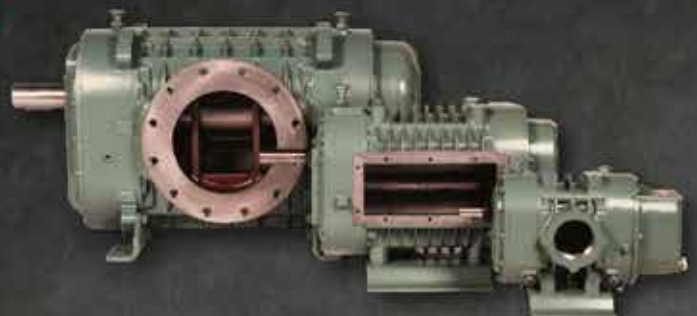

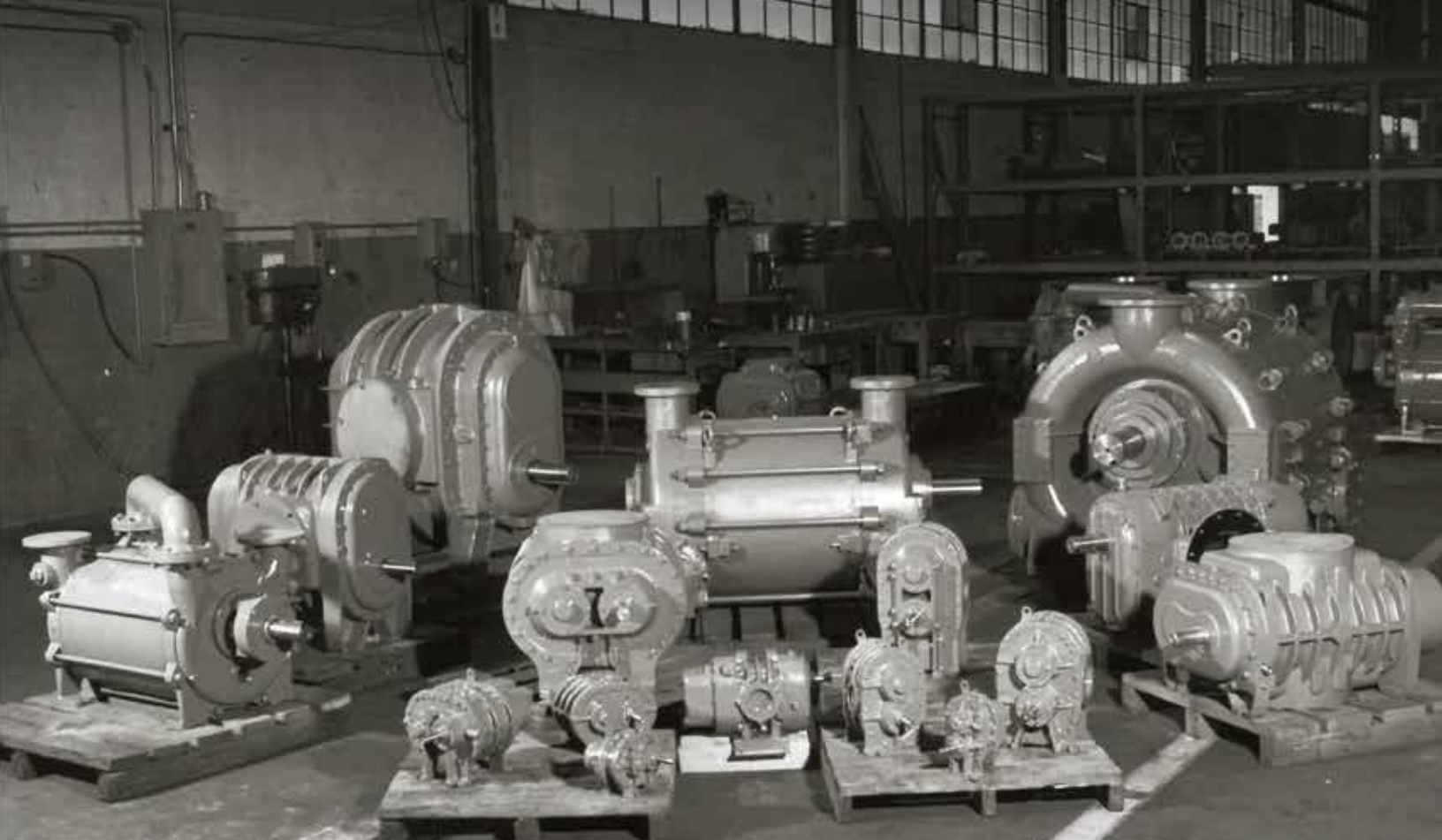

It's all about...

the Complete Package

Gardner Denver has more blower package options than anyone else

We can help you customize your system to meet your needs. More technology designs provides tailored options for you.

- Smart Design
- Easy Maintenance
- Compact Installation
- Quiet Operation
- Enclosed or Unenclosed Available
- Inverter Duty Motors for VFD Capabilities

IQ-RB

SIMPLE

Straight Tri-Lobe

Pressure to 15 PSI

Vacuum to 15 inHg

6,000 Max CFM

3-500 HP

Fixed or Variable Speed

Mechanical Gauges



IQ

SMART

Twisted Tri-Lobe
Pressure to 15 PSI
Vacuum to 17 inHg
1,500 max CFM
7.5-100 HP
Fixed Speed or VFD
AirSmart Controller



IQ-HE

EFFICIENT

3x5 Helical Screw
Pressure to 36 PSI
5,625 Max CFM
7.5-500 HP
Fixed or Variable Speed
AirSmart G2 Controller



Patented
Rotor Profile
High Efficiency
up to 36 PSI



It's all about...

the IQ-RB Blower Package



Features

- RBS blower (tri-lobe design)
- Fixed and variable speed
- Inverter duty motors for VFD capabilities
- Low cost
- Mechanical gauges

Compact Design

- Significantly reduced dimensions
- Optimizes floor space

RELIABLE PERFORMANCE

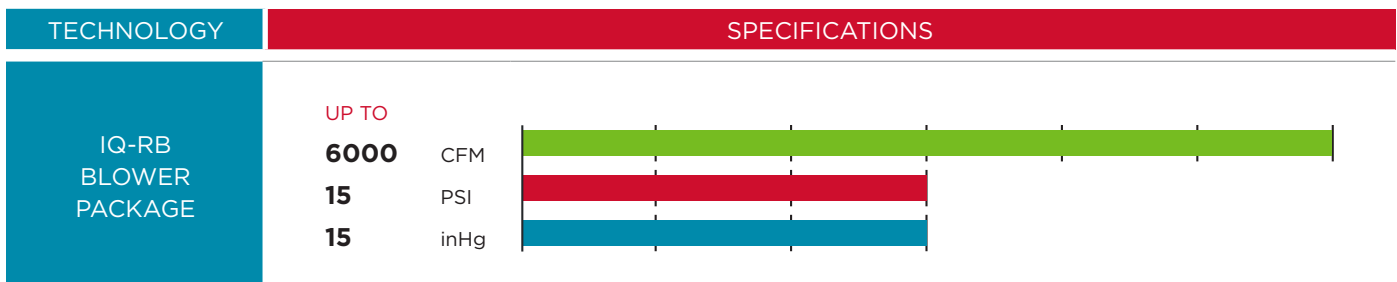

RBS Design Advantages

Dual Splash Lubrication

Reliable dual splash lubrication on both the drive and gear ends for longer product life

Helical Gears

Helical timing gears for smooth and quiet operation at all speeds

Leak-Free Operation

Piston rings and flinger maximize seal life in continuous severe duty applications

Durable Shafts

High strength shafts that allow higher operating pressures and rotation speeds

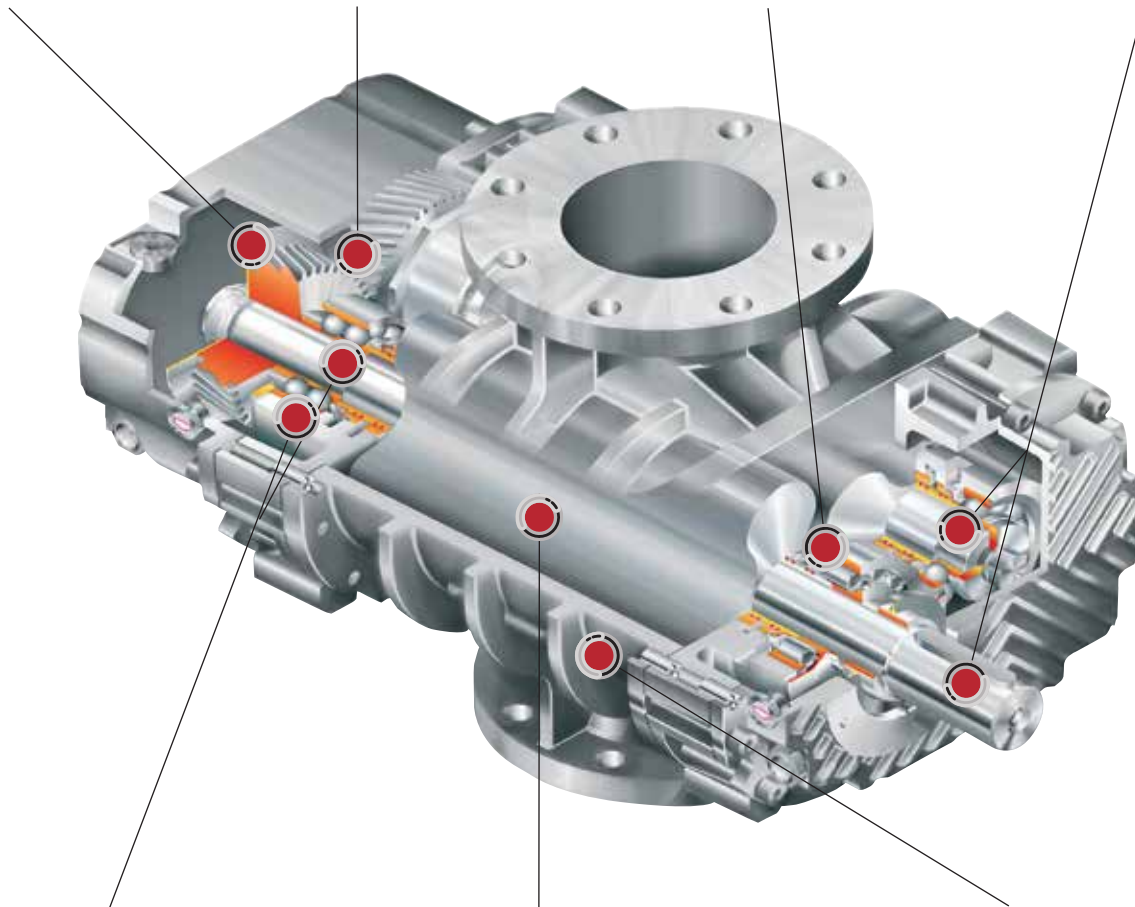

Long Life Bearings

Reinforced roller bearings are calculated for a lifespan of 100,000 hours under the most severe operating conditions

Three-Lobe Rotors

Involute three-lobe rotors offer the highest performances and efficiencies

Single Piece Cylinder

High strength impeller case is heavily ribbed and machined from a single piece of cast iron to retain internal clearances and improve heat dissipation

It's all about...

the IQ-RB Simplicity

Design Features

- Patented design reduces noise
- Compact design = decreased system costs
- Can be installed side-by-side
- Easy access via removable front and upper panels

Quiet Operation

- Unique noise enclosure design with double sound insulation panels
- Tri-Lobe technology reduces flow pulsation
- Discharge silencer
- Patented tunable inlet filter/silencer reduces noise (pictured below)

IQ-RB Sound Level

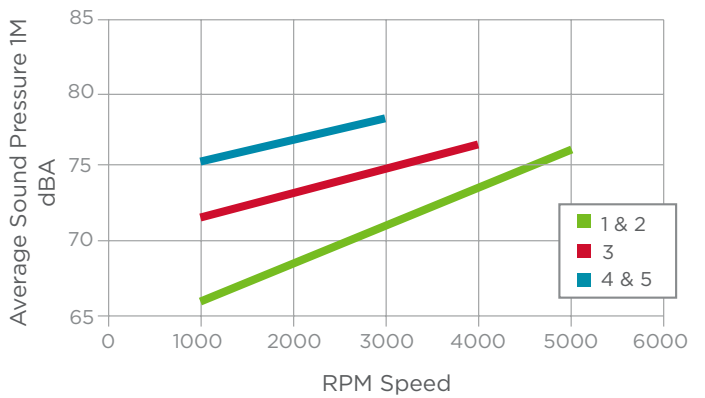

TUNABLE
INLET
FILTER/
SILENCER

We Keep It Simple to Save You Money

Ease of Inspection

- Access: All maintenance operations are performed from the front with the removal of the front panels
- Oil Change: Can be performed with easily accessible fill and drain hoses
- Oil Level Check: Oil levels can be checked via gauges with or without the blower running

Mechanical Gauges

- Inlet filter restriction gauge
- Discharge pressure gauge
- Discharge temperature gauge

Simplified Maintenance

- Minimizes downtime
- Reduces maintenance costs
- Removable panels permit easy access
- Easily viewable oil levels & streamlined oil changes
- Automatic belt tensioning
- Simple belt replacement

FRAME	1	2	3	4	5
HP	3-15	15-60	25-125	60-300	125-500
CFM	150	650	1400	3400	6000

*The range is dependent on vacuum or pressure applications.



It's all about...

the IQ Package



TECHNOLOGY	SPECIFICATIONS									
IQ BLOWER PACKAGE	UP TO 1,500 CFM 15 PSI 17 InHg	 <table border="1"><thead><tr><th>Specification</th><th>Value</th></tr></thead><tbody><tr><td>CFM</td><td>1,500</td></tr><tr><td>PSI</td><td>15</td></tr><tr><td>InHg</td><td>17</td></tr></tbody></table>	Specification	Value	CFM	1,500	PSI	15	InHg	17
Specification	Value									
CFM	1,500									
PSI	15									
InHg	17									

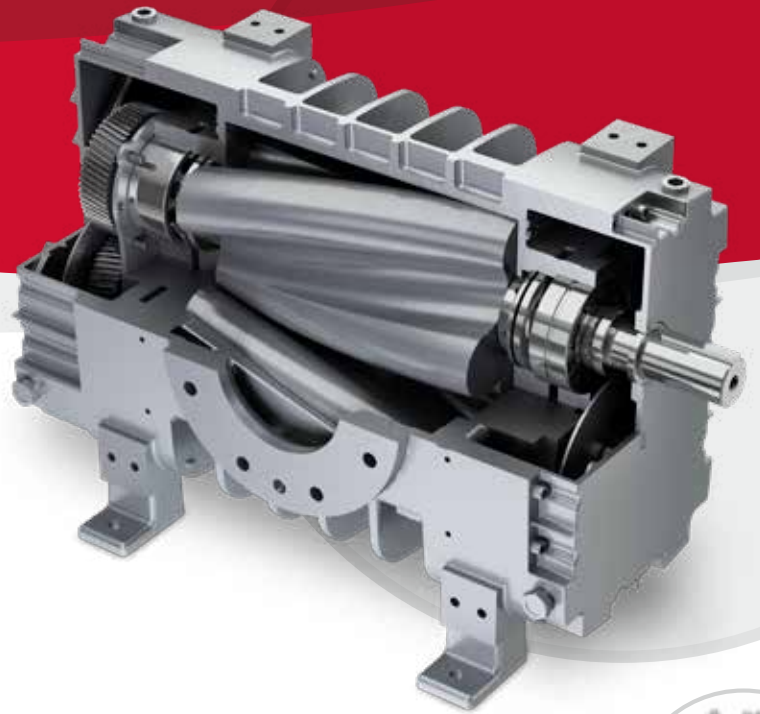

Featuring the HeliFlow Blower Technology

Strong design, reliable performance, and quieter operation achieved through:

- Reduced pulse
 - Discharge pulsation is the chief contributor to high noise levels in blowers
 - The unique helical rotor profile significantly reduces pulsations
 - This reduces noise levels by 4-6 dBA over similar sized, straight-lobe blowers
- Helical gear design reduces noise
- Solid rotors reduce vibration caused by ingested material in rotor cavities
- The HeliFlow has a higher shaft load capacity than all other comparable lobe blowers



REDUCED PULSE = LOWER NOISE = QUIETER OPERATION

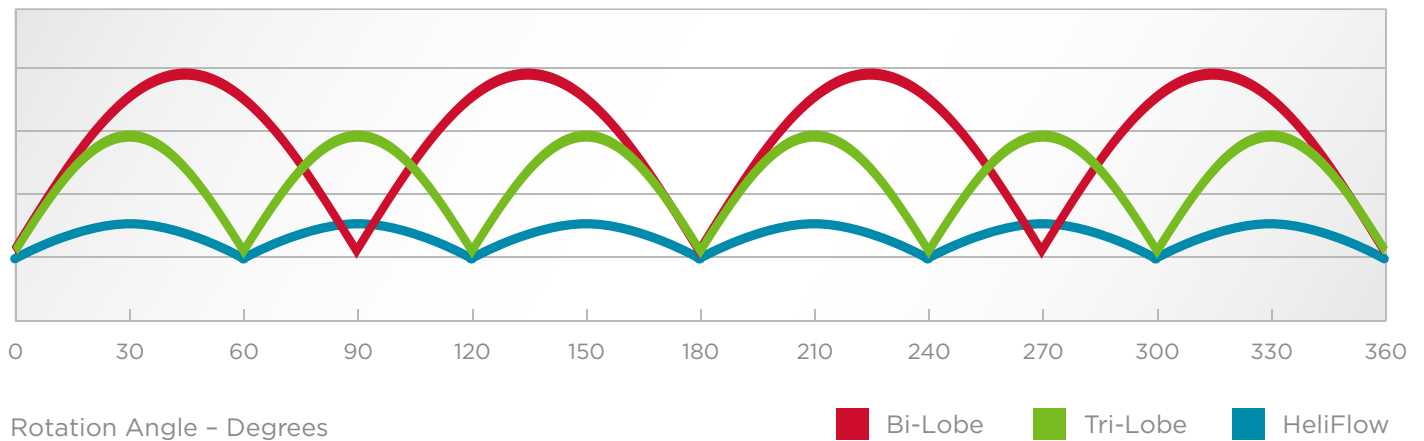

It's all about...

the Peace of Mind



AirSmart Controller

Keeping you in control of your blower package

The AirSmart controller allows up to eight blower packages to be sequenced

- Can be process or timer operated
- Allows distribution of operating hours
- Reduces downtime for maintenance



IQ Advantages

- The IQ package offers quiet operation, strength, reliability, and performance for all applications
- The variable frequency drive and twisted tri-lobe rotor profile offer better efficiency than a straight lobe blower
- Simple transit is attained with slots found on the package base frame



3 STAGES OF PROTECTION

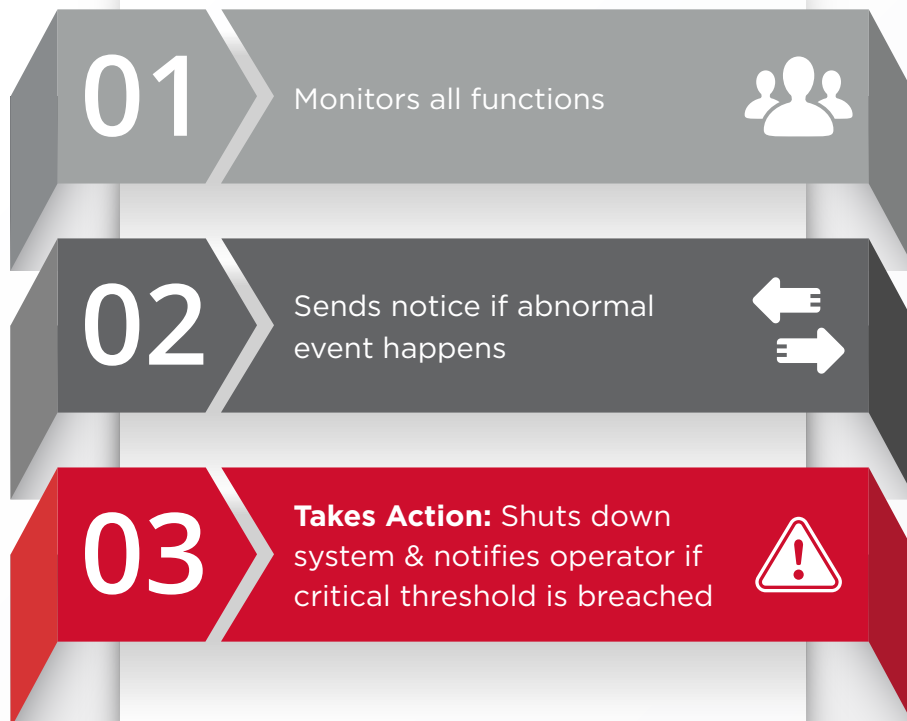

The AirSmart controller uses customizable timer to track maintenance schedules and notify the operator when routine service is required.

It's all about...

the IQ-HE Package

TECHNOLOGY	SPECIFICATIONS	
IQ-HE BLOWER PACKAGE	UP TO 5,625 CFM 36 PSI	

- High efficiency screw technology
- Low energy consumption saves money
- Delivers up to 36 psi
- High pressure conveying
- AirSmart G2 controller for 24/7 protection
- Silent operation
- Compact design
- Flexible options

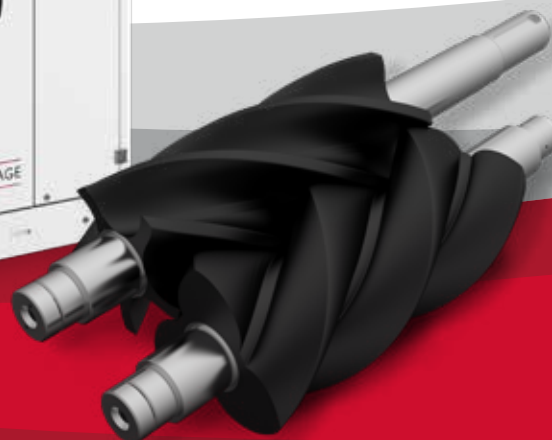

Enclosed & Unenclosed Models

- Mechanical Gauges (Unenclosed Models)
- G2 Smart Controller (Enclosed Models)

High & Low Pressure Packages Available

- 15 psi or Below = Low Pressure
- Above 15 psi = High Pressure

High & Low Pressure Package Force Feed Lube Design Includes

- Oil Pump
- Oil Reservoir
- Oil Filter
- Heat Exchanger
- Oil Demister

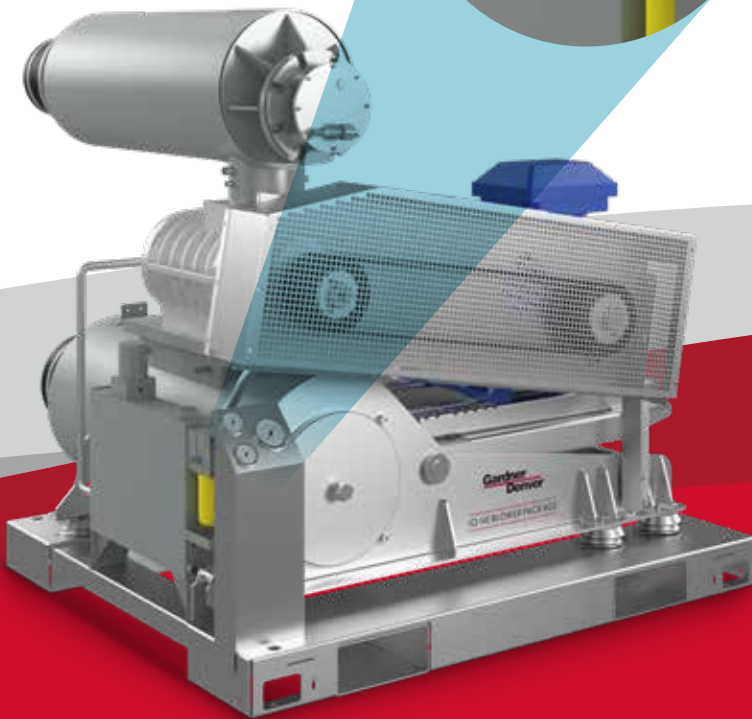
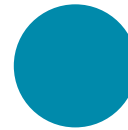

The Right Package
for your Application

It's all about...

the Premium Package

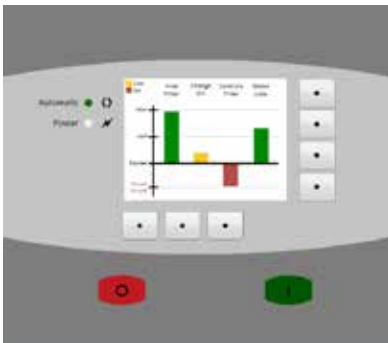

AirSmart G2 Controller Screens

Maximum Capacity with minimum energy consumption

Monitored Operation & Protection

- AirSmart G2 controller
- Constant monitoring
- Highest levels of protection
 - Overpressure/high temperature shutdown
 - Service advisories
- Status indicator
- Maintenance schedule tracking

Maximum Efficiency

- Patented rotor profile with PTFE rotor coating promising consistent performance
- Reduced number of revolutions and energy consumption in all working conditions
- Reduced energy bills
- Quick return on investment



SAVE
UP TO **30%**
ON ENERGY
CONSUMPTION

Flexibility for Your Application

- Offers a turndown capability in flow to meet needs of customer with inverter duty motor
- Suitable for intermittent use with frequent stops and restarts
- Belt drive ensures the right capacity for the application
- High and low pressure options to match customer application
- Available enclosed or unenclosed

Compact Design

- Extremely compact dimensions
- Side-by-side installation
- Optimizes floor space
- All routine maintenance can be easily performed by only removing the front panel

Silent Operation

- Rotor profile
 - Less noise during compression phase
 - Low rotor rotation speed
 - Absence of a step-up gear
 - Sound emissions kept to minimum
- Noise enclosure
 - Designed with optimized air passages and sound pressure reduction capacity
 - Separate from blower = no vibration transmitted to walls
 - Sound-absorbing material consisting of open cell polyurethane foam
- Inlet & discharge silencer
 - Drastically reduce residual pulsations
 - Sound absorption material reduces sound energy

It's all about...

the Simplified Maintenance

Installation

- Can be transported via forklift/pallet truck
- Simple electrical system connection
- Simple piping connections



Maintenance

- All routine tasks can be carried out from the front of the package for easy:
 - Oil change
 - Oil filter replacement
 - Oil pressure adjustments
 - Air filter replacement
 - Belt drive replacement
- Sight glass allows for immediate oil level check even during operation
- Filter clogging and discharge pressure gauges
- Reduces maintenance costs



It's all about...

the Network

We're where you need us



The leader in every market we serve
by continuously improving all business processes
with a focus on innovation and velocity



C. Emery Nelson, Inc.
INDUSTRIAL AND POWER PLANT EQUIPMENT
7631 Commerce Street, Hamel, MN 55340
Ph: 763/ 420-3844 Fax: 763/420-2542

**Gardner
Denver®**

Gardner Denver, Inc.
1800 Gardner Expressway
Quincy, IL 62305
866-428-4890
www.gardnerdenver.com/gdproducts



©2019 Gardner Denver, Inc. Printed in U.S.A.
PD-IQ-GEN 4th Ed. 6/19

 Please recycle after use.